

Spare parts list

19685 Adapter for screens

19685-500-55 - black

*Rev 03

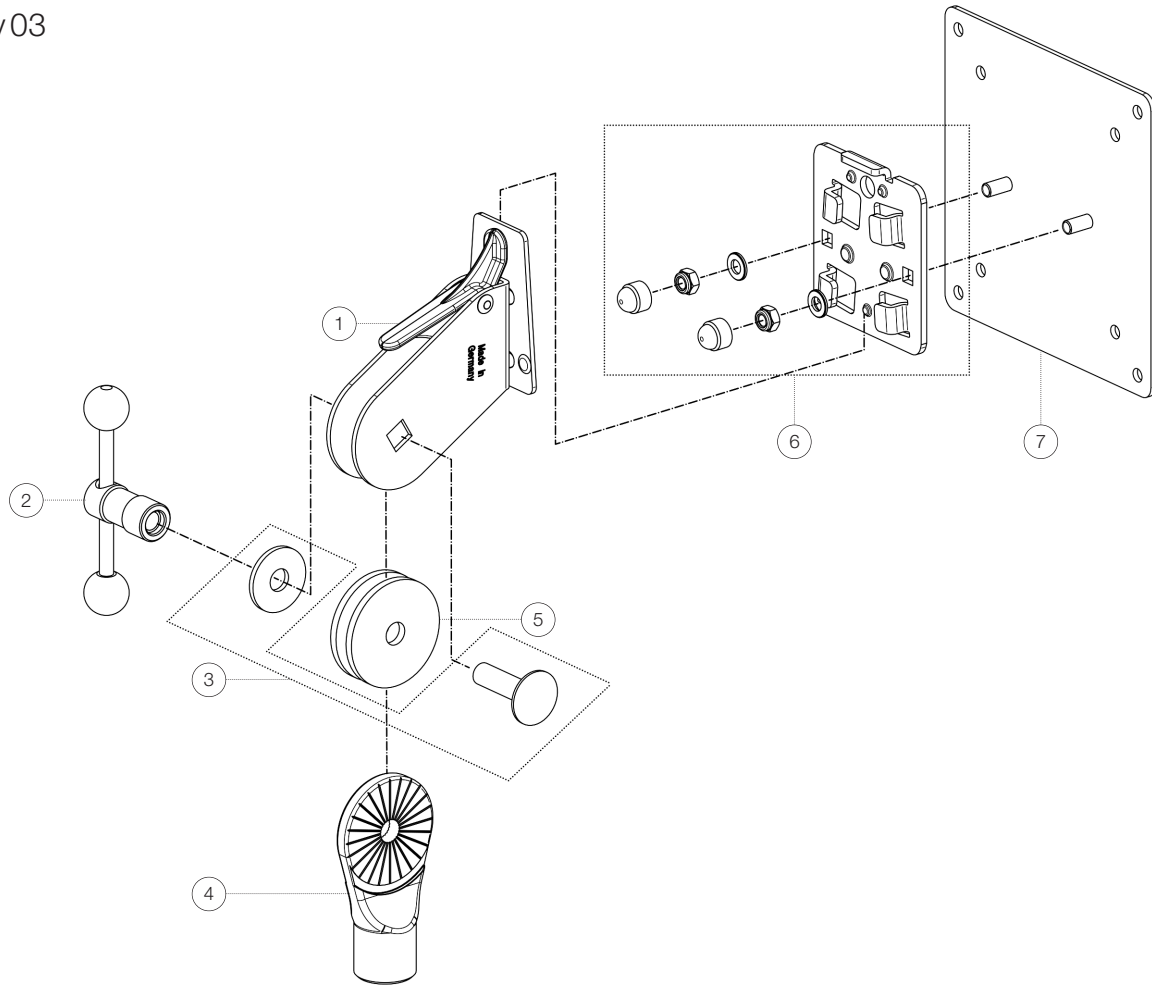

Position	Description	Article No.	Quantity
1	Tilt connector with quick-release fastener complete	6-11810-5-55	1
2	T-bar locking screw	6-30351-1-55	1
3	Rubber washer	03-21-161-55	2
4	Swivel head 5/8"	02-40-440-55	1
5	Screw connection boom arm	3-00-000-019	1
6	Accessories bag connecting plate	6-10068-1-00	1
7	Bearing plate with pins complete	5-19685-1-55	1